

IE-FLIGHT

White paper



1. Executive summary

Intelligent Energy has unveiled a breakthrough in aviation fuel cell technology, launching its cutting-edge high-temperature IE-FLIGHT™ fuel cell system, based on IE's unique patented cooling technology.

This white paper evaluates the potential of the new IE-FLIGHT PEM fuel cell systems to address the challenge of zero emission flight, and specifically the requirement for large and heavy thermal management systems that are needed to dissipate the heat generated by fuel cells. This issue is emerging as a major constraint for fuel cell-powered aircraft, with large heat exchangers causing weight and drag penalties, and therefore a critical area for the industry to address.

This new IE-FLIGHT fuel cell system reduces the size of onboard heat exchangers and reduces aerodynamic drag, whilst maintaining high gravimetric power density and leveraging the proven benefits of high-current density LT-PEM fuel cells. The results from the initial modelling conducted within this white paper show that for a 9 PAX aircraft the block fuel can be reduced by up to 5% based on a IE-FLIGHT fuel cell system with high temperature architecture, compared to conventional fuel cell systems, by reducing propulsion drag. In future aircraft designs, where propulsion drag is predicted to be a greater proportion of the overall aerodynamic drag, that fuel saving would increase.

With this breakthrough, hydrogen fuel cell powertrains become a much more attractive option for future zero-emission aircraft serving eVTOL, sub-regional and regional markets, as well as hydrogen fuel cell powered APUs within future hydrogen combustion powered wide body aircraft. This patented high-temperature architecture is the cornerstone of Intelligent Energy's IE-FLIGHT aviation fuel cell system products, marking a new era in sustainable aviation technology.

Written by:

Dr. Chris Dudfield, Chief Technology Officer

Tim Booth, Technical Lead IE-FLIGHT

Dr. Jonathan Cole, Head of Technology Development, high-power

Jonathan Douglas-Smith, Head of Sales IE-FLIGHT

Dr. Martin Goodwin, Senior Programme Manager

2. Fuel cell overview

Hydrogen fuel cells generate electricity through the electrochemical reaction of hydrogen with oxygen within the fuel cell stack and produce water vapour and waste heat as by-products. This is a clean and efficient way to produce electricity when using green hydrogen as the fuel.

Hydrogen fuel cells are a zero carbon emission technology and as such provide a pathway to meeting net zero goals for the target market applications. They are a direct alternative power source to batteries and combustion engines, which have inherent mass and emissions challenges respectively.

There are various types of fuel cells available which favour different use cases, depending upon the application requirements e.g. mass, operating temperature, mobility, power density and size. Fuel cell technology is extremely versatile and can be found in a range of applications including automotive, aerospace, stationary power, portable power, rail, marine and materials handling for example.

For reference, a comparison of various fuel cell technologies is shown in Appendix 1.

This report focuses on PEM fuel cells since these are generally considered to be the most appropriate fuel cell technology for aerospace applications, due to their gravimetric and volumetric power densities.

3. Fuel cells within aviation

Hydrogen fuel cells offer a zero-emission power source solution for future sustainable aircraft and are a competitive technology for eVTOL, CS-23 and CS-25 class aircraft, (potentially up to 100 seats), as well as for APUs within future wide body aircraft. Aircraft manufacturing primes Airbus and Embraer have launched their own hydrogen fuel cell aircraft development programmes, ZEROe and Energia respectively, in order to leverage the benefits of hydrogen. The Aerospace Technology Institute (ATI) have identified fuel cells and thermal management as key technology bricks for enabling zero carbon aircraft. As part of ATI's "Destination Zero" strategy, the FlyZero project established that a fuel cell system power density greater than 1.5kW/kg is required for fuel cell technology to be viable in aerospace propulsion.

However, aerospace integrators currently working on advanced fuel cell powered aircraft concepts are challenged with the size of LT-PEM fuel cell thermal management systems which are required to dissipate the low-grade heat generated from the fuel cells. The heat generated alongside electrical power within the fuel cell, requires continuous heat rejection to prevent cell overheating and thermal degradation of the cell components. In higher power fuel cell systems, such as those for aviation, the heat output is significant and requires the integration of specific cooling sub-systems. A large thermal management system obviously leads to additional mass and drag penalties, which poses a particular challenge when scaling to larger aircraft.

For aircraft applications, particular focus has been applied to fuel cell power density. However, as development continues towards a viable product the cost of ownership, efficiency, life, robustness and reliability are also to be improved upon. Optimisation of the overall aircraft efficiency requires a holistic and integrated approach, not only through mass reduction but also by reducing aircraft drag with improved thermal management.

4. Fuel cell thermal management

Thermal energy produced as a by-product of the electrochemical reaction requires dissipation. As electrical power output increases more thermal energy is produced leading to a greater challenge in heat dissipation. Cooling requirements and configurations will differ depending on the fuel cell technology and application. There can be considered to be five different methods of thermal management available for PEM fuel cells, depending on the application and balance of plant requirements:

- Air cooling (AC)
- Liquid cooling (LC-LT)
- Evaporative cooling (EC-LT)
- Evaporative cooling with high temperature thermal management (EC-HT)
- Liquid cooled high temperature membrane (LC-HT)

Air cooled fuel cells have the least complex balance of plant in the system, where the air provided for the oxidant at the cathode is also used to remove the heat generated from the reaction. These systems tend to work well in the sub-kW to e.g. 20-30kW region. Above this, the air flow requirements become more demanding, particularly where tight packaging constraints become a major requirement. They are not generally considered for higher power provision in aerospace applications.

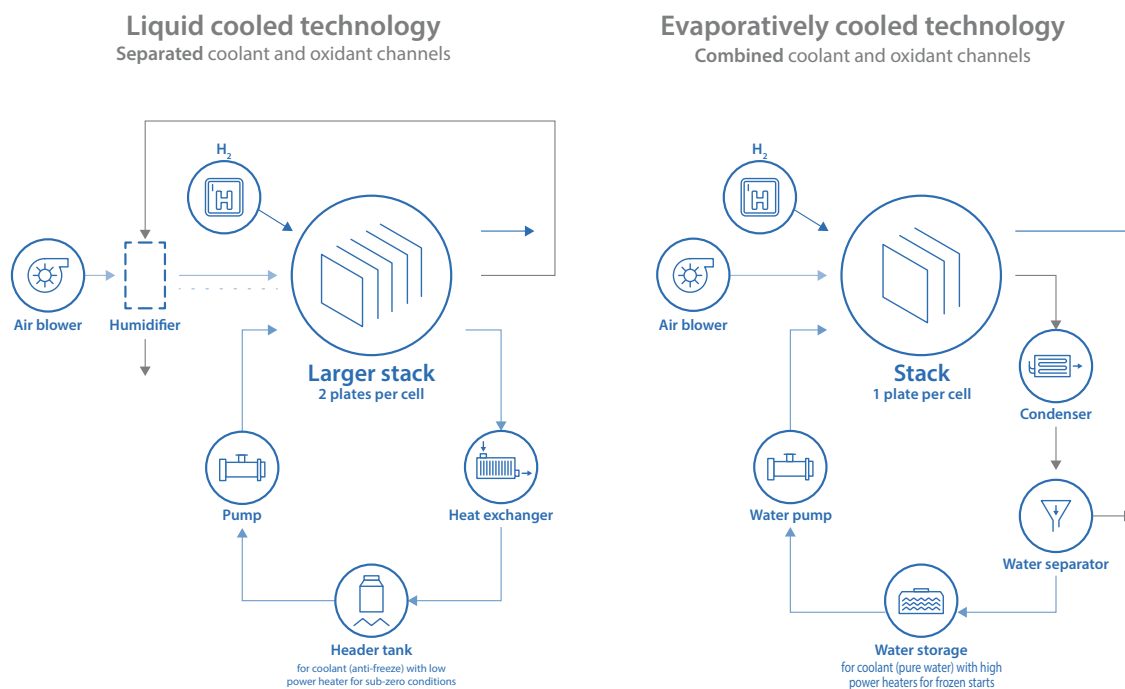

Figure 1 Comparison of Liquid Cooled and Evaporatively Cooled Fuel Cell Technology

For passenger carrying aircraft, high power fuel cell systems are required to unlock the benefits of zero carbon technology for aerospace propulsion. Unlike low power fuel cells that can be cooled using ambient air, high power fuel cell systems require greater thermal and water management necessitating more complex system architectures. For larger fuel cell systems not only does the waste heat need to be removed efficiently, but the humidity of the reactant air also needs to be carefully controlled. The two main technologies used are liquid cooled or evaporative cooled (*Figure 1*).

Liquid cooled (LC-LT) technology is based upon the design of a thermal management system where a coolant fluid (typically a water / ethylene glycol based mixture) is passed through formed channels in a bi-polar plate and the coolant absorbed heat is then subsequently removed through a heat exchanger. In a separate process loop, water vapour is collected from the stack waste gases via a humidifier and transferred back into the stack intake air stream.

Evaporatively cooled (EC) technology involves the injection of liquid water directly into each active cell in the fuel cell stack. As this water evaporates, the thermal energy generated via the electrochemical reaction is absorbed during the water phase change. The evaporated and product water and oxygen depleted air pass through the heat exchanger allowing water to be cooled back to the liquid phase and returned to the water storage tank for further injection into the stack as part of the continuous cooling cycle. The remaining humid air exits via the exhaust.

An EC fuel cell system does not contain a humidifier, as water injected into the cathode stream within the stack acts to locally humidify each cell fully. Therefore, under transient load conditions, the availability of humidity in an EC cell is significantly improved over an LC system with an external humidifier. Therefore, this will lead to improved cell performance during fast transient load changes and can have a significant benefit in reducing the battery capacity needed on board to help manage power transients.

Liquid cooled high temperature (LC-HT) technology is similar to LC-LT but uses a high temperature membrane electrolyte allowing the stack to operate at a much higher temperature (>120°C). This reduces the size of the thermal management system due to the higher temperature delta between the hot and cold side of the heat exchanger.

EC with high temperature thermal management (EC-HT) and liquid cooled high temperature membranes (LC-HT) both target improved thermal effectiveness through increasing the temperature delta across the heat exchanger. The resulting increased heat exchanger efficiency drives a reduction in heat exchanger size and hence will reduce the BoP mass and aircraft drag.

However, HT-PEM cells and electrolyte materials are at a lower TRL and MRL and have lower electrical performance (current density and life) and higher platinum electro-catalyst content than commercial LT-PEM products, offsetting benefits from smaller heat exchangers. HT-PEM commercialisation timescales, and ultimate suitability for aerospace, remain risks. The Intelligent Energy EC-HT solution uses proven commercial membrane technology combined with an improved thermal management system, providing a lower risk and viable aerospace solution.

Simpler construction

An evaporatively cooled fuel cell is a simpler construction with fewer components than a liquid cooled fuel cell. In a liquid cooled cell, heat is removed via liquid cooling channels on one side of a separator plate, with reactant channels on the other face. Therefore, two separator plates are required between each cell, to provide channels for 3 separate fluids across the whole cell area. The separator plates in a liquid cooled cell require effective clamping force and/or localised welding of plates to reduce the overall electrical contact resistance losses.

In an evaporatively cooled cell, a single flow field plate contains both the cathode and anode reactants on either side of a single bipolar plate. No additional cooling plate is required, and a reduced electrical contact resistance is achieved. This results in an evaporatively cooled stack of a smaller cell pitch and lower mass, aiding overall volume package and beneficial to overall power plant weight. *Figure 2* below summarises these benefits.



Less balance of plant so
lighter
than our competitors
(no separate humidifier)



smaller HEX
compared to liquid
cooled fuel cell systems



Single cell
plate design enables
compact and minimal
material stack



Less parts mean more
cost effective
and quicker
to manufacture

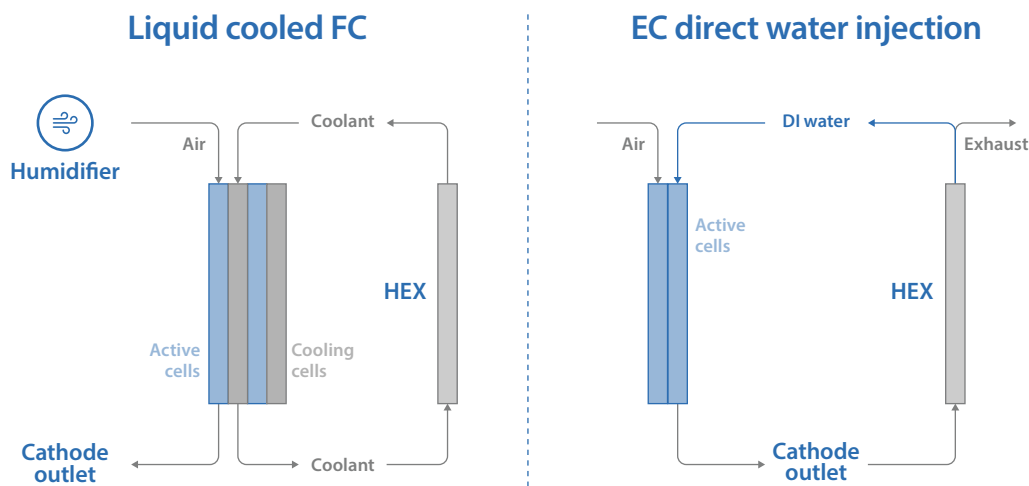
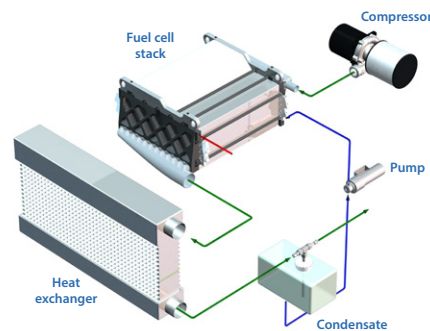

Figure 2 - Benefits of evaporatively cooled technology

5. High temperature architecture

IE-FLIGHT hydrogen fuel cell products from Intelligent Energy, feature a new higher temperature heat rejection architecture delivering:

- Reduced heat exchanger size
- Lower aerodynamic drag
- High gravimetric power density

Intelligent Energy are delivering a higher heat rejection temperature, through compression of cathode exhaust fluid between the fuel cell stack and heat exchanger. This increases the pressure and temperature inside the heat exchanger, raising thermal effectiveness and reducing the size when compared to other fuel cell systems. An example of a possible nacelle layout is shown in [Figure 3](#)

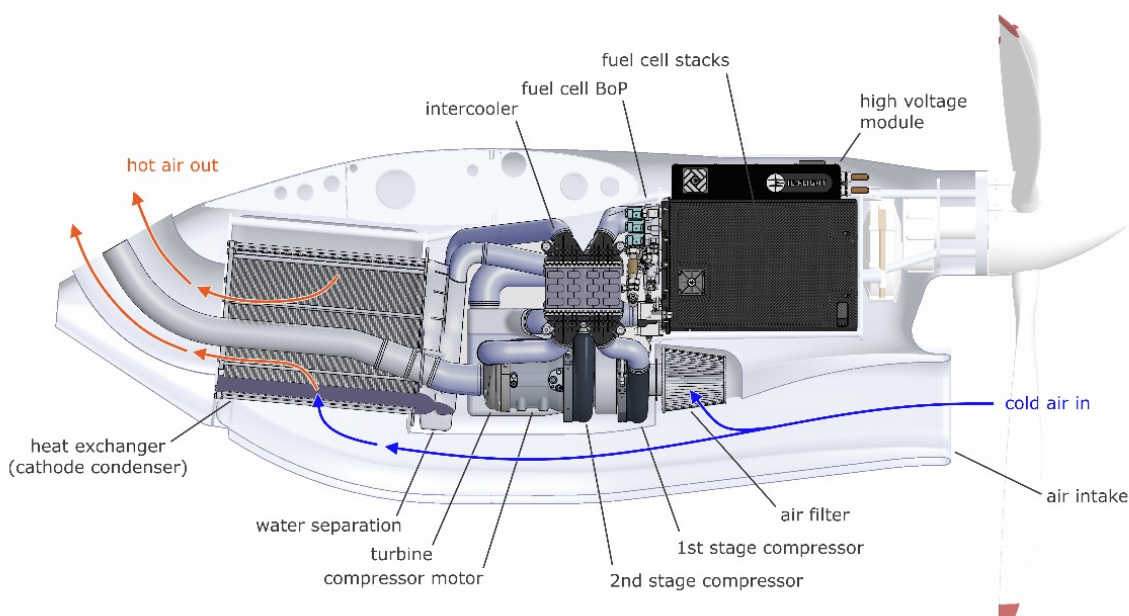
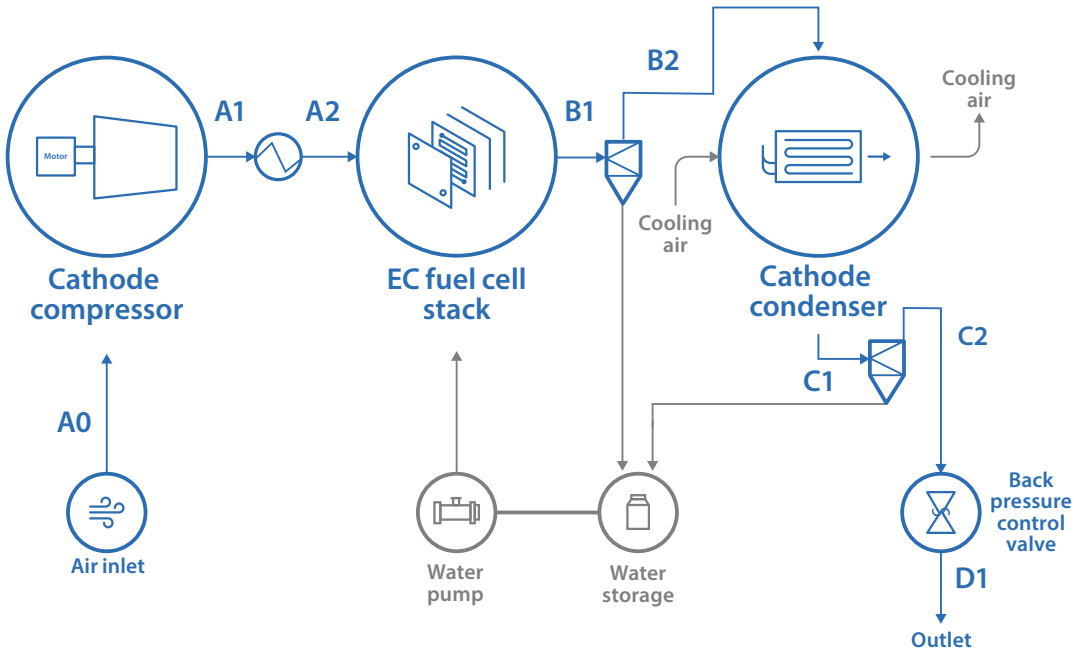

Figure 3 - Conceptual integration of an IE-FLIGHT 300 fuel cell product in a future fixed wing propulsion system

The two-stage cathode process compression is complemented with a turbine, downstream of the heat exchanger, to recover energy from the cathode flow and ensure effective overall efficiency. [Figure 4](#) shows the differences between the existing EC-LT and EC-HT architecture.

LT - typical cathode side architecture used in, for example, existing IE-DRIVE HD100 product



HT - New proposed system architecture, for future IE-FLIGHT 300 product, pending further work

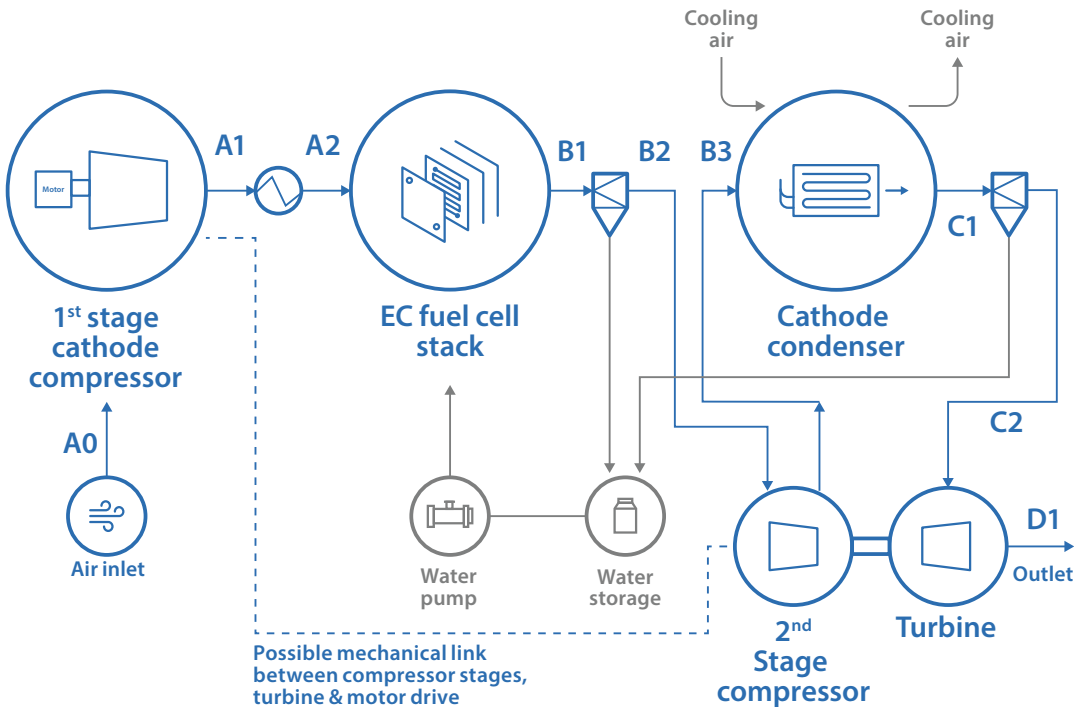

Figure 4 - Comparison of conventional EC and EC HT architecture

6. Benefits for aircraft integration

IE architecture reduces heat exchanger size

Considering a 300kW system as a suitable scalable building block for aerospace, an analysis has been undertaken to compare heat exchanger size between the EC-HT and LC-LT architecture (Table 1). For simplicity, the analysis compared the wetted area change for a square single pass heat exchanger, and maintaining a constant pressure drop. For an equivalent system an EC-HT architecture could operate with a 23% reduction in heat transfer area compared to LC-LT. This can be achieved due to the higher heat exchanger inlet temperature with the EC-HT system whilst the phase change on the heat exchanger hot side generates a higher heat transfer coefficient. A separate study carried out by Loughborough University showed for an equivalent system an EC system could operate with a 27% reduction in heat exchanger frontal area¹.

	LC-LT	EC-HT
Hex size - heat transfer area relative to LC-LT	100%	77%
Mass (kg)	34	26 (-8kg)

Table 1 - Comparison of size and mass of heat exchangers

The area change can be considered proportional to the heat exchanger mass resulting in the dry mass of the EC-HT heat exchanger reducing by 8kg relative to a LC-LT system. This assessment is based on a dry weight. Once the coolant is added to the LC system the delta to an EC system could be over 50% larger, so at aircraft level the assessment is considered conservative.

The benefits of high temperature architecture are further demonstrated when considering the environmental operating conditions. The second stage compressor can be used to optimise the thermal management across the flight profile allowing the heat exchanger to be minimised. The compressor can dynamically control heat exchanger inlet temperature, minimising parasitic power during normal operating conditions and during hot day conditions the compressor can increase the inlet temperature. Whereas in a LC system where the hot side inlet temperature is fixed, the heat exchanger sizing is driven by the worst case hot day conditions (e.g. >ISA+28) and therefore is sub-optimal for typical operations leading to increased drag.

High temperature EC architecture impact on aircraft level performance

Aircraft modelling approach

Key parameters, namely mass, performance (power and efficiency), and drag can be traded to optimise the fuel cell system integration onto an aircraft. In principle, the

1. A comparison of evaporative and liquid cooling methods for fuel cell vehicles, A. Fly*, R.H. Thring, 28 June 2016

lightest fuel cell is one that operates near its maximum power point. However, the resulting lower efficiency will produce more waste heat and at an aircraft level this will lead to larger fuel tanks and increased drag from a larger heat exchanger, and hence higher block fuel. It can also lead to reduced stack life due to harder running of the cells.

The goal is to find a virtuous spiral, where improving efficiency, leads to a reduced thermal management system leading to less drag which reduces the power demand and amount of fuel consumed which reduces the size of tanks required. This can also provide benefits for stack and system life and emergency cases due to increased operational flexibility of the system.

The initial goal for aviation is to achieve a 1.5kW/kg system. However, for the best overall aircraft solution an optimal fuel cell system needs to be derived, balancing; mass, efficiency and thermal management. The EC-HT architecture has been developed to be adaptable to customer requirements. While it has additional parasitic loss due to an extra stage compressor this is offset with turbine energy recovery and reduced heat exchanger size which reduces overall aircraft drag.

An aircraft level assessment has been undertaken using a twin engine 9 passenger aircraft model, to consider several system trades. This aircraft is a good representation of a possible fuel cell powered aircraft application and allows a back-to-back comparison of different fuel cell technologies whilst minimising influence by aircraft design. The modelling considers an aircraft with a propulsion system installed in two nacelles, storing gaseous hydrogen in a 1m³ tank with a 10% gravimetric efficiency. The wings and fuselage are fixed. The study considered the differences in propulsion system efficiency (including parasitic losses), mass and drag for LC, EC-LT and EC-HT technologies to show the effect at an aircraft level on block fuel for a given mission. The mass has been baselined for an EC-LT system at 1.5kW/kg and deltas have been applied based on heat exchanger sizes for the relevant technologies. It has been assumed at this stage that the LC-LT and EC stack performance is similar.

The study considered a value of 20% for the propulsion drag as a proportion of overall aircraft drag. This is a reasonable approximation due to the larger nacelle and thermal management system for fuel cell systems. No data is publicly available for this aircraft type, but for larger aircraft, values between 10% and 40% have been quoted.

Aircraft sensitivities

A parametric study of the aircraft has highlighted the aircraft sensitivity to the fuel cell system parameters identified. By isolating these parameters, it has been possible to gain greater insight into the behaviour of the different technologies for comparison. In reality, the parameters are interlinked and adjusting one will influence the others. In this study each of the parameters have been assessed against block fuel.

Changing the amount of propulsion drag as a proportion of overall aircraft drag and keeping mass and efficiency the same, shows that for every 1% increase in aircraft drag, there is approximately 1% increase in block fuel.

Changes in propulsion system mass have a smaller influence on aircraft fuel consumption. A 50kg increase in mass increases the block fuel by 0.8%. This is because 2 x 200kg systems equate to about 10% of the aircraft mass. For this reason, the study has assumed the baseline LC and EC systems are of an equivalent weight.

A 1% improvement in fuel cell system efficiency leads to a reduction of 1% block fuel.

This is due to the associated reduction in reserve fuel weight, with a more efficient propulsion system requiring less fuel for the same mission. It should be noted that this study considered a fixed size fuel tank. For full design optimisation the efficiency has a larger impact, with a 1kg fuel saving leading to possible tank mass reductions of 9kg (assuming 10% gravimetric efficiency).

Table 2 summarises the design trades from the parametric study.

	Delta	Change in fuel block
Drag	+1% aircraft drag	+1%
Mass	+50kg	+0.8%
Efficiency	+1% FC efficiency	-1.01%

Table 2 - Impact of fuel cell parameters on aircraft block fuel

Cruise speed is a parameter not directly linked to fuel cell design but the increased maximum landing weight (MLW) and drag of fuel cell aircraft means they will be more sensitive to cruise speed. Figure 6 shows the relationship between cruise speed and block fuel. For this assessment a cruise speed of 140kn was used to compare technologies as it provides an acceptable mission range without needing larger fuel tanks which would exceed the MLW of the aircraft.

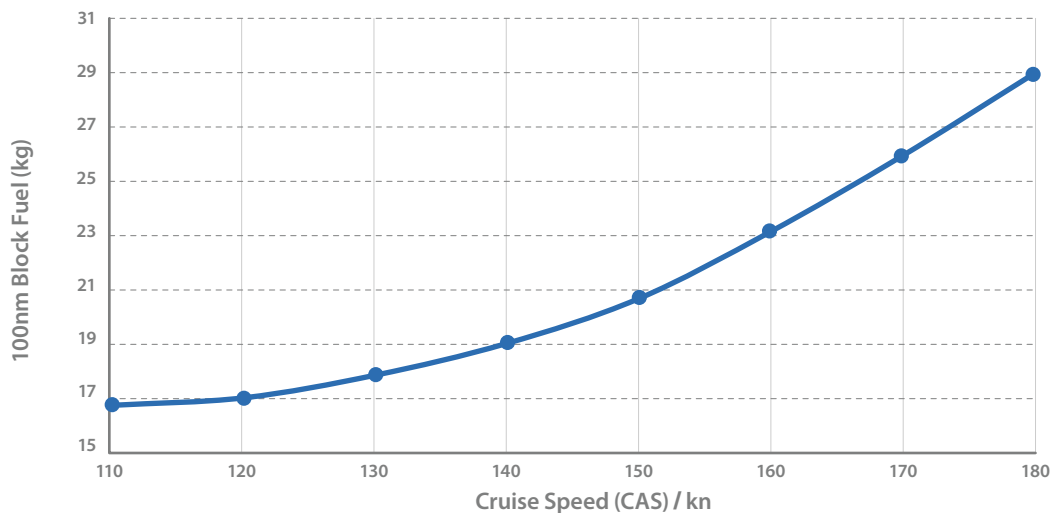

Figure 6 - Comparison of cruise speed against block fuel

The parametric study was used to compare the different fuel cell technologies at aircraft level. Fuel flow maps were generated for each technology which included any parasitic losses from compressors and electrical power. The EC-HT does have a higher parasitic load, however, this can be mitigated through operating the second stage compressor to the specific operating conditions. In addition, the reduction in heat exchanger size and associated drag reduction will have a significant effect on aircraft block fuel. Heat exchanger assessments show that moving to the high temperature architecture could generate a 23% reduction in heat exchanger size, which could approximately translate into a similar percentage saving in propulsion drag. So, an aircraft with 20% propulsion drag could be reduced by 4% when applying drag reduction from an EC-HT system.

Further tuning of the second stage compressor will offer several percentage point improvements in block fuel. *Table 3* shows the results of the study.

Preliminary analysis shows that EC-HT architecture will meet the power density target of 1.5kW/kg and have a block fuel improvement of up to 5% for the analysed mission.

	EC-LT/LC-LT	EC-HT	EC-HT +20% cells
Fuel cell rated power per aircraft (kW)	600	600	600
Propulsion mass per aircraft (kg)	400	400	420
Percentage aircraft drag	20%	16%	<16%
Block fuel (% relative to LC)	0%	-1%	-5%

Table 3 - Comparison of key aircraft parameters against different EC fuel cell systems

Fuel cell system optimisation for aircraft

The trade study highlights the importance of overall system optimisation. Moreover, for applications where gaseous hydrogen is the preferred on-board storage technology, then EC-HT offers an even greater benefit. This is as a result of the low gravimetric density of fuel storage. Optimising the aircraft level solution for operators, in terms of block fuel, life and operational adaptability will influence the target system specific power density. The EC-HT architecture has several benefits that can be exploited to get the best aircraft solution.

The use of a single lightweight bi-polar plate in EC fuel cells means a larger EC stack can be used with a smaller proportion of the overall system weight relative to a LC system. Utilising this option will improve the fuel cell efficiency and life, as well as reduce the thermal load for a given power. In most cases at an aircraft level, the efficiency gain will lead to a significant reduction in tank mass and reduce operating costs. *Figure 7* shows how a 20% increase in the number of cells leads to 5% reduction in block fuel. This is still a conservative estimate based on the study assuming a fixed tank size. Furthermore, the use of a single plate design in an EC fuel cell stack reduces the impact on volume and mass if the number of cells is increased.

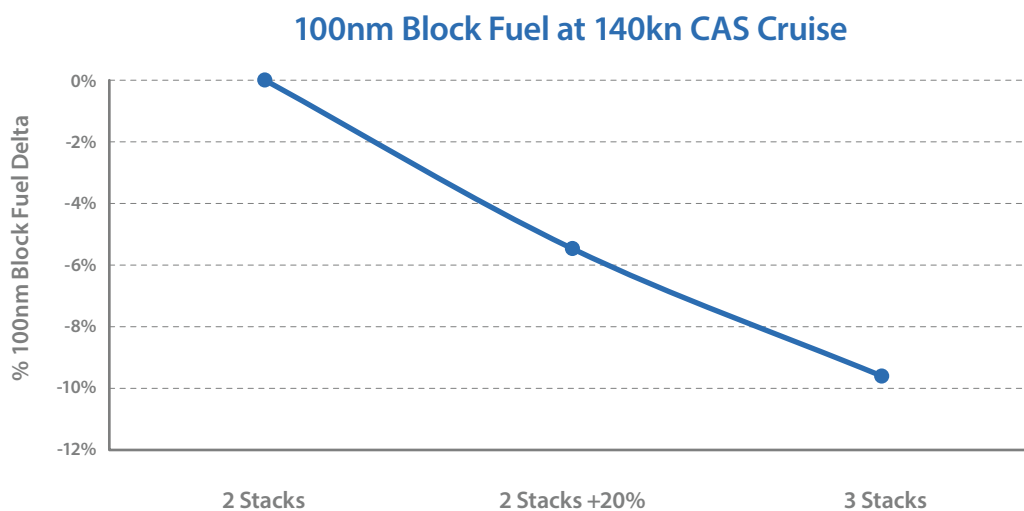

Figure 7 - Comparison of fuel cell stack size against block fuel

The EC-HT architecture can also provide further aircraft operational benefits. Section 6 discussed the dynamic control of the HT system. This allows the heat exchanger to be sized for more standard operating conditions and uses the HT system to adapt to the hotter operating conditions. This will increase the parasitic energy consumption during these conditions but improve it at more standard operating conditions providing an overall operational benefit.

The trade study considers a cruise speed at 140kn. A smaller heat exchanger in the HT system will reduce drag which becomes increasingly important as cruise speeds increase.

As new aircraft are developed around fuel cell systems and embed new technologies such as lightweight, high aspect ratio wings the importance of reducing drag from the propulsion thermal management system becomes more important. The EC-HT thermal management will help reduce the impact on aircraft drag.

7. IE-FLIGHT™ fuel cell system and battery technology

For small aerospace applications such as eVTOLs, fuel cell and battery technology are considered to be the two viable power source options. However, the specific energy density of current battery technology is a limiting factor for eVTOL aircraft range and payload. *Figure 8* below illustrates the performance of battery technology at various levels of maturity and the performance requirements for a variety of eVTOL manufacturers to meet their required range and payload.

An IE-FLIGHT fuel cell system solution with various sized 350 bar gaseous storage options has been overlaid in *Figure 8*, to show the significant benefit the fuel cell technology presents over batteries. The higher specific energy of the Intelligent Energy fuel cell system leads to greater potential payload and range, providing enhanced operational flexibility.

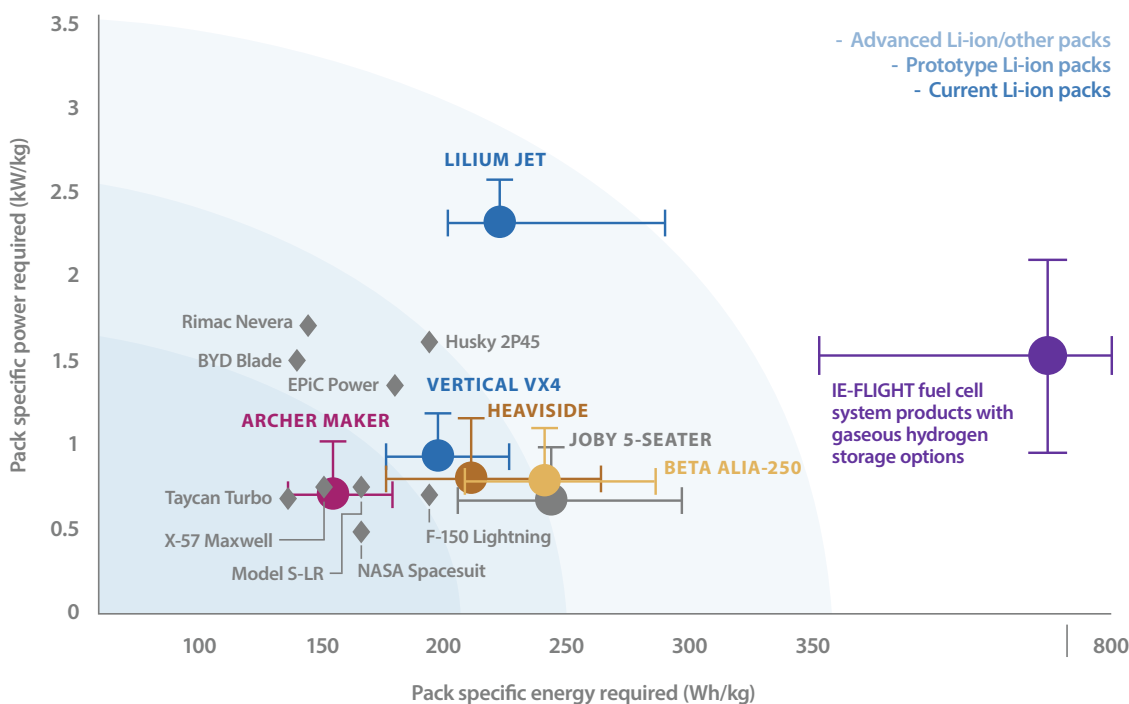

Figure 8 - Carnegie Mellon study on battery technology performance, eVTOL manufacturer battery requirements to meet their range requirements, and IE-FLIGHT™ fuel cell system performance.

8. Latest developments

Intelligent Energy is a partner in the Aerospace Technology Institute (ATI) H2GEAR programme, developing the next generation of power dense and durable aerospace evaporatively cooled fuel cells.

Intelligent Energy's latest cell design has advanced through H2GEAR, delivering excellent current density and optimised packaging, building an effective foundation for application in future aerospace propulsion. As shown in [Figure 9](#), further cell enhancements within H2GEAR are still underway to drive the technology to a more power dense solution in line with the ATI fuel cell roadmap and underpinning fuel cells in aviation.

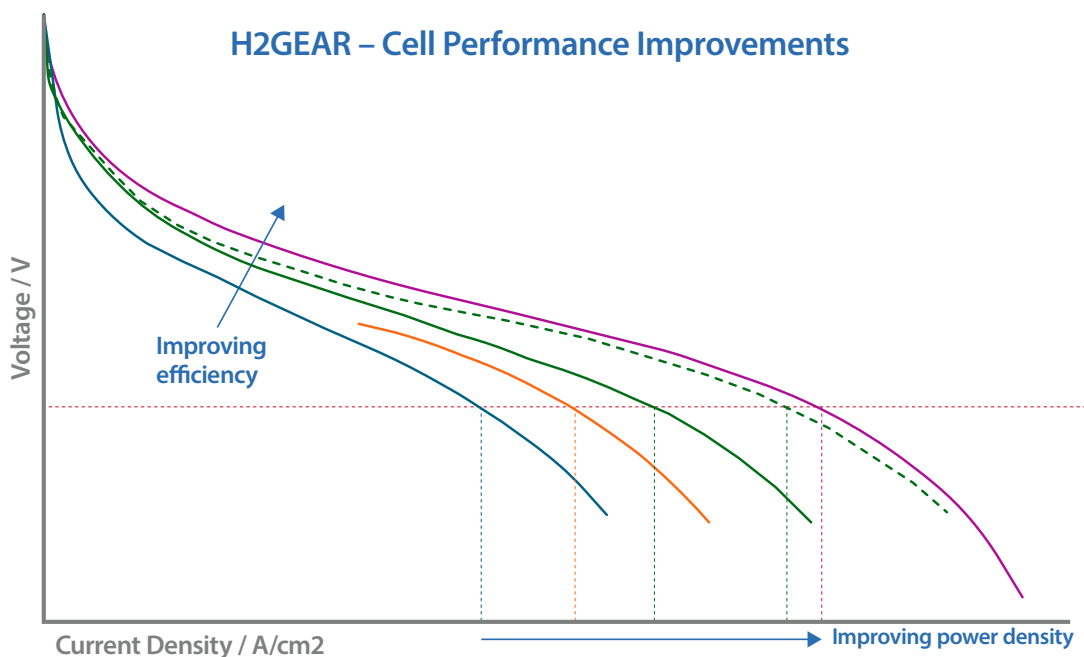
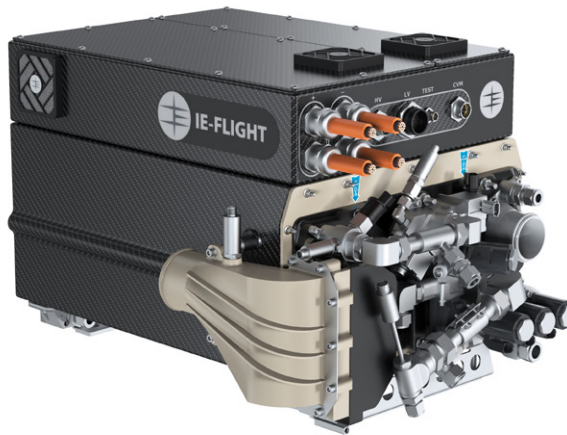

Figure 9 - Cell polarisation curve showing continuing performance improvements during H2GEAR

Under H2GEAR, significant emphasis has been placed on innovative packaging and mass reduction to elevate the power density of the stack module as shown in [Figure 10](#) below. This technology advancement will form the basis of the stack module to be integrated into a full system for aerospace applications.

H2GEAR stack module



Aero FC stack

Auto FC stack

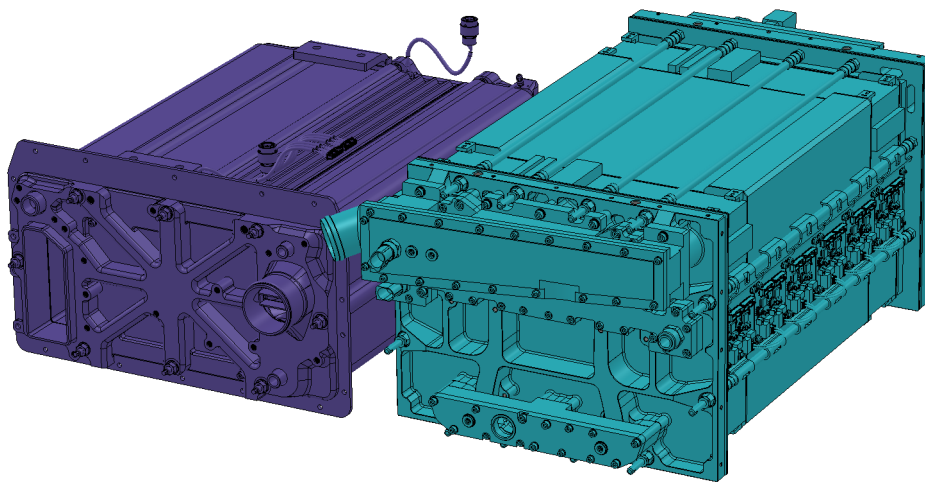

Figure 10 - Stack module developed under H2GEAR and size comparison with automotive stack

Aircraft level assessments discussed previously are taking place to assess both the optimal size and efficiency of the stack, whilst aircraft level integration is being undertaken to establish a core pod mounted layout of the system suitable for future adoption. *Figure 11* shows an example of a possible layout. A conceptual hardware demonstration of the novel high temperature system will be conducted as a precursor to a full system development programme.

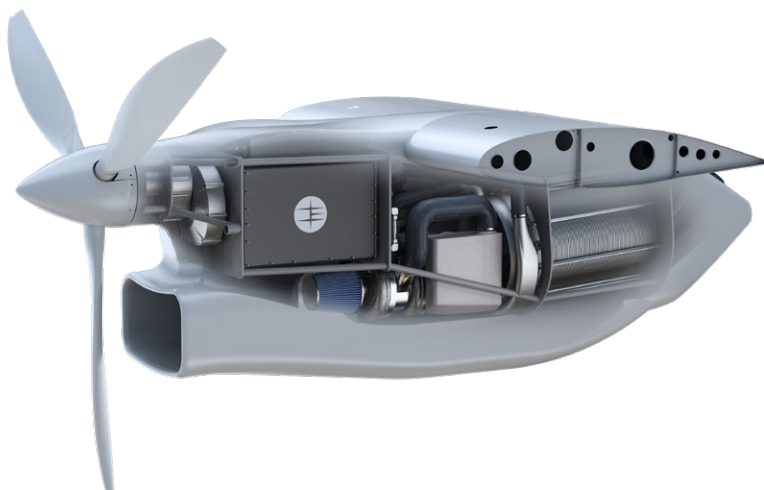

Figure 11 - Aircraft level integration of an EC hydrogen fuel cell system

9. Applications for IE-FLIGHT™ Technology

IE has used market forecast studies to identify eVTOL, sub-regional and regional aircraft markets as the likely first adopters of zero-carbon propulsion technologies with initial deliveries by 2030.

The IE-FLIGHT fuel cell system is being designed as a scalable building block to cover the full range of applications illustrated in *Figure 12* and offer a competitive advantage for our customers. The target markets are listed below and IE is engaging with customers to exploit the benefits of IE-FLIGHT technology and realise zero carbon flight.



eVTOLs



Sub-regional aircraft

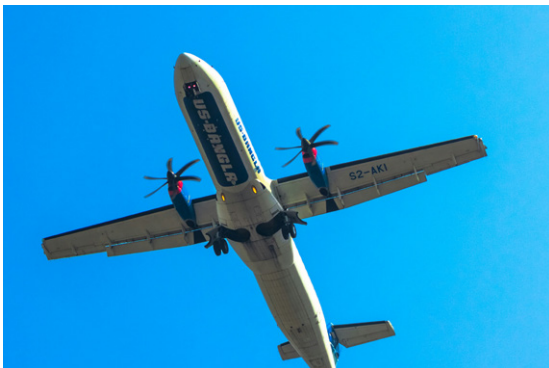

Regional aircraft



APUs

Figure 12 - IE-FLIGHT target applications

10. Conclusion

Intelligent Energy's high temperature fuel cell system architecture has been presented and the material benefits outlined for a 1.5kW/kg IE-FLIGHT system targeting eVTOL, CS-23 and CS-25 class aircraft propulsion, and APUs for future large aircraft. The new high temperature heat rejection architecture delivers:

- Reduced heat exchanger size
- Lower aerodynamic drag
- High gravimetric power density

The system delivers a higher heat rejection temperature, through compression of cathode exhaust fluids between the fuel cell stack and the heat exchanger. This increases the pressure and temperature inside the heat exchanger, raising thermal efficiency and hence enabling a size reduction when compared to other fuel cell system heat exchangers.

Modelling summary:

- Use case - Assessment initially conducted around a 9-seater aircraft flying a 100nm mission with a cruise altitude of 5000 feet and speed of 140kn.
- Optimisation - System was optimised around drag, mass and efficiency to achieve an optimal aircraft solution.
- Key modelling trade - 1% change in drag leads to 1% change in block fuel

Results

- Smaller heat exchanger - High temperature architecture drives a 23% reduction in heat exchanger area leading to lower drag.
- Block fuel reduction - Preliminary analysis shows that EC-HT architecture will meet the power density target of 1.5kW/kg and deliver a block fuel improvement of up to 5% for the analysed mission compared to conventional fuel cell systems
- Operational efficiency improvement - Evaporatively Cooled High-Temperature architecture is dynamically tuneable to further optimise operational efficiency, removing the need to size heat exchanger for a worst-case hot day condition.
- Higher cruise speed - Lower drag of EC-HT allows higher cruise speed with a reduced associated fuel penalty.
- Future aircraft benefits - Propulsion drag is expected to be higher percentage of total aircraft drag for new aircraft design, hence the reduced drag EC-HT architecture will provide further benefits to the industry.
- eVTOLs payload and range benefits - Compared to anticipated future battery performance, IE-FLIGHT fuel cell system offers higher specific energy which leads to greater potential payload and extended range, providing enhanced ROI potential for operators.

Trade studies of two stage compressor performance, heat exchanger configuration, and turbine size, continue, to optimise system component selection for the range of applications. Several different mission and altitude conditions are now under consideration.

The IE-FLIGHT system now enters the next phase of design, intended for fixed wing engine replacement and new eVTOL airframe applications, through collaboration with partners, customers & integrators. Intelligent Energy intends to use this high temperature architecture within future IE-FLIGHT fuel cell system products.

To find out more information about IE-FLIGHT™ technology and to discuss its benefits within your application, please contact sales@intelligent-energy.com.

11. Appendix

Comparison of different fuel cell types

	PEM	Solid Oxide	Alkaline	Phosphoric Acid
Electrolyte	Polymer membrane	Ceramic	Potassium Hydroxide	Phosphoric Acid
Anode catalyst	Pt	Ni + YSZ (ceramic)	Ni, Pt, Pd	Pt
Cathode catalyst	Pt	LSM (ceramic)	Pt, Pd, Ag, MnO ₂	Pt
Typical fuels	Hydrogen	Nat gas, ethanol, biogas	Hydrogen, Ammonia	Hydrogen, Methanol
Typical operating temp	50-100°C	50-1000°C	40-75°C	150-200°C
Cell efficiency	50-60%	60%	60-70%	40-50%
Typical application power	1W to +1MW	10W to +1MW	500W to +200kW	100W to +400kW
Cell power density / Wcm²	2	1	1	0.3
Pros	Quick start-up Transient response Small Lightweight	Fuel flexibility Efficiency	Quick start-up Efficiency Low cost Low temp operation	Operational stability Maturity Simple construction Impurity tolerance
Cons	Hydrogen purity Humidity sensitivity Catalyst expense	Start-up time Transient response Expensive raw materials	Relatively large CO ₂ sensitivity Liq electrolyte management	Power densities Corrosive liquid & vapour Catalyst expense
Applications	Automotive Aerospace UAV Marine Portable Rail Stationary power MHE	Power plants Marine CHP	Back-up power Space Military Stationary power	Stationary power CHP



IE-FLIGHT®

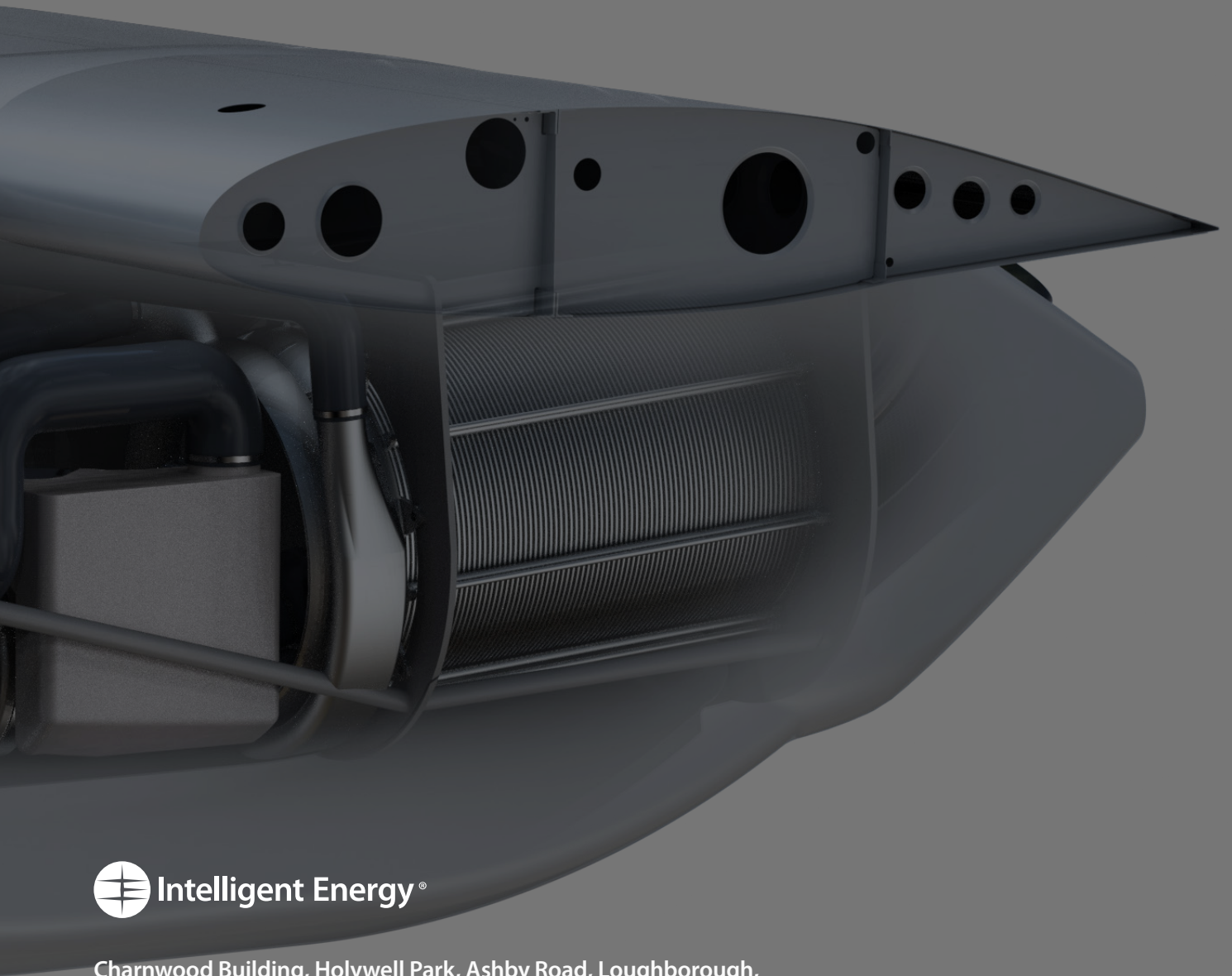

 **Intelligent Energy®**

Charnwood Building, Holywell Park, Ashby Road, Loughborough,
Leicestershire, LE11 3GB, UK
+44 (0) 1509 271 271
intelligent-energy.com